



BLANCO UNIT
drink. prep. clean.

INSPIRATIONS 2024.

Stylish and seamless combinations to create your perfect kitchen water hub.



Front cover:

Tap: CHOICE Icona in brushed stainless steel.
Product code: 527656.

Sink: ETAGON 500-U in volcano grey.
Product code: 527258.

In cabinet: SELECT II 40/2 combi.
Product code: 527854.
CHOICE.All water conditioning unit.
Product code: 527661.
Water carafe.
Product code: 527671.

This page:

Tap: SONEA-S Flexo in solid brushed stainless steel.
Product code: 526616.

Sink: ADIRA 6 S in volcano grey.
Product code: 527604.

BLANCO ARE THE EXPERTS.



Drink. Prep. Clean. Everything you need, all in one place. Sink, tap, integrated organisation and waste management, seamlessly combined in the BLANCO UNIT for a stunning, creative kitchen hub at the heart of your home.

Discover more at blanco.co.uk

GERMANY SINCE 1925

As a German company, founded nearly a century ago, we are among the world's leading manufacturers of kitchen taps, sinks, and integrated waste and organisation systems.

We are passionate about the heart of your kitchen, the sink-space is the hub, where tasks need to run smoothly and efficiently. It's the most important place in the kitchen, and our many years of experience in cutting-edge technology can make it even better.

Welcome to The BLANCO UNIT Inspirations Collection. Did you know that we spend more than half of our time in the kitchen using the sink, tap and waste area? Which is why BLANCO focuses on improving how you can use this space. Adding intelligent features, introducing new designs and innovative materials to make kitchen life easier, everyday.

With the BLANCO UNIT it all flows naturally. Sinks, taps and waste management systems are the most commonly used items in the kitchen. However, they are rarely given the consideration during planning that they deserve.

We're looking to change that with the BLANCO UNIT: seamless solution for a creative yet practical kitchen hub at the heart of your home.

The BLANCO UNIT combines our premium products together, letting you choose the right items to suit your kitchen style and lifestyle. There are different elements you need to consider when putting together your ideal kitchen hub. On the following pages we're providing some curated inspiration to help choose your perfect BLANCO UNIT.

WHAT IS THE BLANCO UNIT?

Everything you need for your kitchen life and lifestyle, all in one place.



Tap: drink.hot EVOL-S Pro in black matt
Sink: ETAGON 500-U in stainless steel
Waste System: SELECT II Compact 60/2

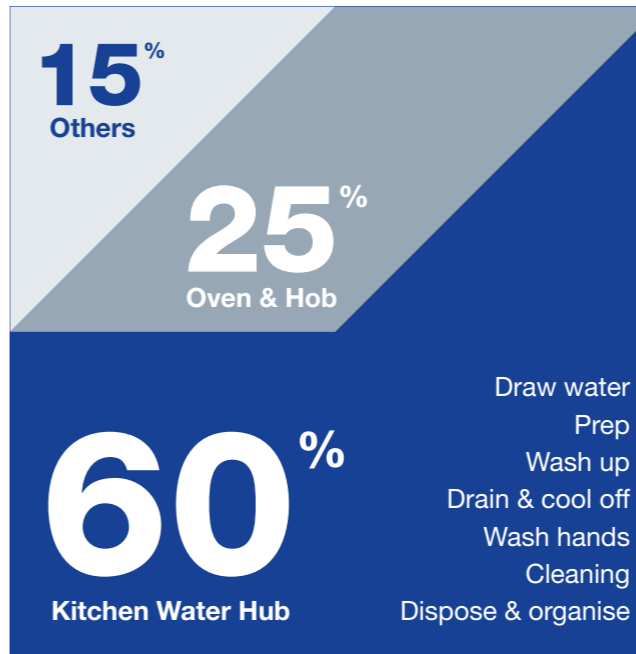

Where we spend our time in the kitchen in the UK



DRINK. PREP. CLEAN.

With the BLANCO UNIT you can create the perfect place to drink, prep and clean, that fits your style and your lifestyle. Day-to-day drink making, food preparation and cleaning now take place at a sophisticated sink area, combining all three tasks to perfection. Vegetables are peeled, washed and off-cuts disposed of in just a few simple movements. Tea made simple with a boiling water tap, cool drinks created with pure filtered water and life made easier with features including flexible or pull-out sprays.

The space under the sink, that no-go-area of chaotic (but important) storage becomes perfectly tailored with an integrated waste, in-cabinet organisation or food waste disposer.

All of this with millimetre precision, premium quality and ingenious ideas to make kitchen life easier everyday.

And within this special BLANCO Inspirations Collection we will be showcasing how the BLANCO UNIT can fit seamlessly and stylishly within any kitchen design you choose.

A PERFECT COMBINATION.

We spend about 60% of our time in the kitchen at the sink. It's where we fill our glasses, prepare food, rinse dishes, get rid of food waste, store cleaning products and separate the recycling. So it's important to ensure that things happen quickly and efficiently here. Having everything you need within easy reach and working together smoothly is key.

With the BLANCO UNIT daily cooking, food preparation and cleaning become simply easy, saving you space, energy and time, making those essential daily tasks an absolute breeze.



Sink: ETAGON 6 in SILGRANIT rock grey



Tap: SONEA-S Flexo in solid brushed stainless steel.
Sink: ADIRA 6 S in volcano grey.



Tap: LINUS-S Sink: SUBLINE 500-U both in SILGRANIT volcano grey

THINGS TO CONSIDER WHEN CHOOSING YOUR BLANCO UNIT.

It is essential to be aware of the cabinet width in which your sink will be installed. The bowl, (or bowls in the case of a multi-bowl sink), will need to fit into this space. Each sink in this brochure will show a minimum cabinet required to house it successfully.

STEP ONE: SELECT YOUR TAP.

Are you looking for instant true – 100°C water, the highest quality cold filtered water, or perhaps you want both? Do you need a pull-out spray, or want a semi-professional style tap?

We have a huge selection of top-quality mixer taps, with award-winning designs – find the ideal tap for your kitchen. But, before choosing your BLANCO tap it is essential to check whether you have a high or low pressure water system. More information about this is on page 63.



INSTALLATION FORMATS.



Inset sinks

Inset sinks are installed from above into a pre-prepared hole in the worktop. These sinks are compatible with any work surface, including laminate. It gives you the widest range of sink shapes, sizes and styles to choose from. The frame of an inset sink sits on top of the work surface.

Undermount bowls

Undermount sinks are installed underneath the work surface and therefore require a solid surface worktop such as granite or wood; they are not compatible with laminate work surfaces.

Belfast / apron front bowls

Belfast sinks can be fitted undermount, as pictured above or inset with a slight raised edge profile. Belfast sinks are either 'dropped-on' to a purpose-built cabinet or by using installation brackets.

STEP TWO: CHOOSE YOUR SINK OR BOWL.

BLANCO sinks and bowls are available in an array of different sizes, with a range of installation methods, colours and multi-functional solutions for every standard base cabinet. Whether you are creating a contemporary space and want the latest in undermount designs or stunning inset sinks with drainers, or if you want a farmhouse style bowl for a more traditional look – we have them all.

Three high-quality materials also offer you the option of designing the BLANCO UNIT your way: Beautiful Silgranit® composite, timeless stainless steel or luxurious ceramic. The choice is yours.



STEP THREE: WASTE LESS SPACE.

Reclaim that no-mans-land area under your sink with BLANCO waste organisation systems and food waste disposers. Whether you are looking to organise your cleaning products, store pet items or sort your recycling, we have a system for you. The BLANCO range of organisation and waste management systems give you options for most standard sized, hinged door or pull-out drawer cabinets.

Food waste disposers (FWD) are very convenient when it comes to disposing of leftovers quickly, hygienically and easily. They cut down the amount of waste in the organic waste bin and lower the amount of material sent to landfill sites.



BLANCO UNIT INSPIRATIONS.

We have curated a range of BLANCO UNITS to reflect on our latest innovations and kitchen designs so you can create the perfect BLANCO UNIT to match your space and needs. Additionally you can create your own ideal BLANCO UNIT from browsing our range of products at blanco.co.uk.

Inspiration#1.

Modern kitchen designs blend functionality with being aesthetically pleasing and includes innovative features coupled with clever storage solutions.

Create endless possibilities in the kitchen with new CHOICE Icona and CHOICE.All, the tap and drink.system that together provide a simple solution for all types of water. Just one simple installation lets you enjoy water your way with personalised pre-sets – the level of sparkle, the temperature, filtered or unfiltered, all tailored to individual taste buds. The compact system fits discreetly under the sink and can pair with storage or waste organisation solutions too.

Add warmth to a modern grey kitchen theme, with striking metal accents for a touch of richness. The CHOICE Icona in satin dark steel, coupled with matching InFino® Coloured Component set, creates a distinctive, coordinated, and contemporary aesthetic. Combine these satin dark steel elements with the ETAGON 500-U in Silgranit® volcano grey to create a tonal look with a harmonious colour palette. Then finish with the SELECT II 40/2 Combi waste and organisation system, which sits neatly next to the CHOICE.All water conditioning unit. It provides particularly good access to it for changing the filter or CO₂ cartridges and has a shelf above it for storage for new cartridges. This innovative BLANCO UNIT is distinctive and has style and substance in abundance.





Inspiration#2.

Having a kitchen space that looks as good as it functions is a priority for most people. High tech, high spec kitchens with elevated finishes are becoming more and more popular as we expect our kitchen to keep up with our busy lives.

Enjoy water your way with cold, hot, chilled, boiling, filtered and sparkling water – all in one place. The combination of semi-professional tap CHOICE Icona and water conditioning unit CHOICE.All provides one solution for all types of water choices. Pair with the ETAGON 500-U in Silgranit® volcano grey, to harmonise with the brushed stainless steel CHOICE Icona tap. The compact CHOICE.All system fits discreetly under the sink and can couple with the SELECT II 40/2 Combi and Orga shelf for clever storage or waste origination, rounding off this innovative and multi-functional BLANCO UNIT.

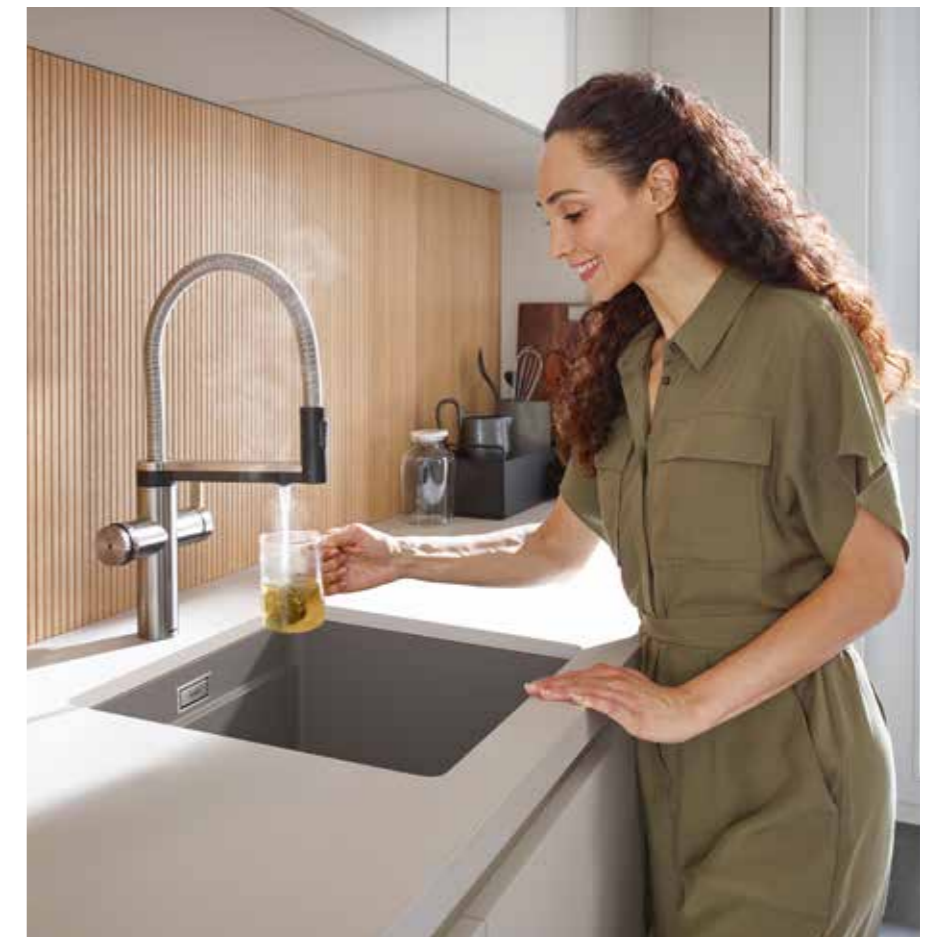



Inspiration#3.

An exclusive look, stylish and warm, dark steel has a fine texture and a velvety feel. Truly versatile, its harmonious tone matches easily with a large palette of colours and materials. It can be used as a unique feature aesthetic to make a bold statement in any space.

The CLARON 700-U Dark Steel Edition is an elegant and striking bowl design with a dark grey surface. Here stainless steel shows its trendy side and impresses with its unique colour as well as functionality. The BLANCO CULINA-S II is an exquisitely designed semi-professional tap, available in accompanying satin dark steel to create a striking, harmonious combination. Pair with the FWD Max for a hard-working and aesthetically pleasing BLANCO UNIT.





Inspiration#4.

Today's modern kitchen seamlessly combines function, aesthetic and innovation where every square inch needs to work hard. That is no truer when considering the kitchen water place, it should be contemporary in style and suitably ergonomic.

The SONEA-S Flexo is a precision crafted designer semi-professional mixer tap with accents of black for the modern kitchen. And the spacious ADIRA 6 S impresses with its functional features including the multifunctional ADIRA folding grid which can be used as an additional work level on the sink or draining board. These two together will definitely make a contemporary statement in your kitchen. Finishing off with the SELECT II 60/2, you have a multipurpose BLANCO UNIT with style and substance.





Inspiration#5.

Intense, modern, luxurious... black is indisputably elegant. Often used within interior design to visually ground a room with its depth of tone, it can be used as the main aesthetic or to make a bold feature in any space. Layer black on black, or bring warmth and contrast to a mainly black kitchen, by introducing a feature accent like a tap in stylish metallics.

The drink.hot EVOL-S Pro is a gamechanger for the modern kitchen, providing the exact amount of boiling hot or filtered water you need at the touch of a button. It is available in three different finishes to suit your ideal kitchen aesthetic. Paired with the ETAGON 500-U in Silgranit® black and a SELECT II Compact 60/2 waste organisation system, this combination of tap, sink and waste system delivers a practical and multi-functional, yet stylish BLANCO UNIT.





Inspiration#6.

White in a kitchen reflects light, making the space feel larger and look pristine. White, with its versatility and simplicity is the perfect backdrop to add a few harmonised features in an accent colour, like gold, for added interest or to elevate the overall design.

The LINUS-S in satin gold is sophisticated and opulent. It has a minimalist design with a high quality metal spray. When paired with a SUBLINE 800-U sink, in Silgranit® soft white, with InFino® satin gold set, you have a harmonious and luxurious co-ordinated combination. And when combined with a BOTTON II 30/2 waste organiser you have a BLANCO UNIT that makes a statement of sophistication.





Inspiration#7.

Having a considered approach to your kitchen's colour scheme matters, and nowhere is more important than the water place. Colours and finishes can help you create the perfect style, whether you want it to be light and bright or rustic and organic, or maybe you want a clean, contemporary look.

Create a visually pleasing BLANCO UNIT by combining contrasting colours for your tap, sink and drainage components to make a statement or go for a more uniform tonal look. Whatever your preference, create a coordinated colour palette for your kitchen to get a really individual look. Choose coloured drainage components in a range of finishes, to match your tap in the same look. Here the SUBLINE 500-U in Silgranit® tartufo, has an elegant design and when paired with the LINUS-S in satin platinum with matching Coloured Components, you have a very harmonious BLANCO UNIT. Or go for a more rich, dark colour palette, with the matt black LINUS-S and matching Coloured Components coupled with a striking Silgranit volcano grey SUBLINE 500-U sink.



Inspiration#8.

Including white in kitchen design is still a very popular choice because it adds an element of bright, airiness and doesn't require a lot of stressful colour decisions. BLANCO's Silgranit® white shade is incredibly easy to live with and so versatile, it can be combined with a dark hue worktops for a distinctive, contrasting look or paired with warmer hues for a more neutral look.

The CATRIS-S semi-professional tap in chrome has a striking, distinguished design, with the flexible spout and stainless steel spring, making a stylish statement at the water place. When paired with a SUBLINE 700-U sink in Silgranit white you have a hard-working but attractive union. Especially when combined with the FWD Medium, providing the most hygienic way to dispose of food waste, you can finish off your BLANCO UNIT with added functionality.





Inspiration#9.

Do you love the purity and elegance of a white kitchen but want to add some warmth and variety? Visually break up the different sections of the kitchen with a mix of textures and finishes, adding accents of neutral colours like black, grey and silver. This way you'll maintain the simplicity of a white colour scheme but with a bit of diversity.

The SONEA-S is a classic semi-professional tap design with accents in black for the modern kitchen. It's a high quality design in solid brushed stainless steel. The METRA XL 6 S in white is a practical and spacious sink. Add a FWD Medium and there you have a flexible and multi-functional BLANCO UNIT that certainly makes kitchen life easier.



Inspiration#10.

Grey is a very versatile colour in kitchen design. Whether you just add touches of it, or use it as the dominant colour, grey tones can conform and complement or help transform pretty much any kitchen theme.

The CANDOR Twin has a high-quality design in solid stainless steel and an elegant high arch. It pairs well with the METRA 6 S Silgranit® in versatile rock grey, which is a practical and spacious sink. And with the FWD Medium and the BOTTON Pro 60/3 waste system you have an extremely practical but stylish BLANCO UNIT to suit busy kitchen life.



Inspiration#11.

Stainless steel is a classic choice that always looks stylish and elegant. It is also a very practical material, which is why it is so popular. Stainless steel is easy to clean and maintain, which makes it a great material for kitchen appliances and accessories, plus it complements any kitchen design scheme.

The robust ANDANO 500-U in classic stainless steel has an elegant design and high quality features. Combine it with the CATRIS-S Flexo Filter in PVD steel, for a timeless pairing. It's a sophisticated semi-professional tap which dispenses filtered water directly out of the tap whilst still maintaining a refined design. Clever optional accessories like the stainless steel Top Rails and Multifunctional Colander in stainless steel help to really make the most of the space around the sink. Add the BOTTON II 30/2 and you have a practical and very hygienic BLANCO UNIT.



Inspiration#12.

It can be hard to get the perfect balance in your kitchen between light and dark tones, thereby creating some visual contrast. Light shades are a winning colour choice for kitchens, as they offer a contemporary and clean look. And by adding striking dark features throughout, this makes a really stylish contrast that feels very modern.

The MAX II in matt black is a practical and elegant tap. Couple it with the SONA 6 S in Silgranit® black – a solid, hardy sink with a roomy main bowl and practical additional bowl. Include optional accessories like the Multifunctional Wire Basket for added functionality around the sink. Add on the FWD Medium and the BOTTON II 30/2 and you have a very solid, functional BLANCO UNIT.

SPECIFICATION AND INSPIRATION OPTIONS.

If you liked the look of some of our inspirations on the previous pages but still can't decide which best suits your style or kitchen specification you can view alternative sink sizes, colour options and waste and organisation choices on these pages.

Inspiration#1&2.

BLANCO CHOICE Icona

NEW



Key Features

- Semi-professional tap delivers cold and hot mixed water plus filtered chilled, hot and sparkling water – all in one place
- Precisely control the bubbles (for sparkling water), temperature, or quantity to dispense and save 4 personal settings conveniently via the BLANCO app
- Colour-coded LED rotary wheel with touch control (start/stop) to select filtered water options
- Separate outlet for refined filtered water and mixed water, from a combined rotating arm
- Two-jet shower for mixed water with flexible spring hose and precise magnetic hold
- 5 stage filtration removes limescale and impurities

Specification

Hot	
Volume	
Sparkling	
Filter System	
High Pressure	
Extendable spray	

Colour shown is satin dark steel. Product code: 527659. Must be purchased with CHOICE.All water conditioning unit. Product code: 527661. Total RRP: £3,198 inc. VAT.

Other colour and finish options



Brushed stainless steel
Product code: 527656.
Must be purchased with CHOICE.All water conditioning unit.
Product code: 527661.
Total RRP: £2,998 inc. VAT.



Satin gold
Product code: 527658.
Must be purchased with CHOICE.All water conditioning unit.
Product code: 527661.
Total RRP: £3,198 inc. VAT.



Black matt
Product code: 527657.
Must be purchased with CHOICE.All water conditioning unit.
Product code: 527661.
Total RRP: £2,998 inc. VAT.

BLANCO CHOICE.All

NEW



Key Features

- Delivers water your way; filtered boiling hot, sparkling and chilled, plus mixed hot and cold
- Intuitive operation via touch display on the unit or in the BLANCO app for customisation options
- Compact water conditioning unit fits discreetly under the sink
- Up to 750ml of chilled sparkling water stored and available for immediate use
- Up to 3 litres of filtered boiling water stored in a quality stainless steel boiler

Waste and organisation options

BLANCO SELECT II 40/2 Combi

NEW



Key Features

- Meticulously designed solution for BLANCO drink.systems, making good use of the base cabinet, providing easy access to the water conditioning unit for CHOICE
- Integrated shelf helps keep everything in arms reach, great for storing cleaning products
- Total capacity = 26 litres (2 x 13 litre bins)
- Can be used in any base cabinet 600mm or greater

Product code: 527854.
RRP: £574 inc. VAT.

BLANCO SELECT II 40/1

NEW



Key Features

- Total capacity = 30 litres (1 x 30 litre bin)
- Can be used in any base cabinet 600mm or greater

Product code: 526304.
RRP: £538 inc. VAT.

BLANCO ORGA Shelf 60P

Key Features

- Innovative organisation space for various uses, whilst hiding the front of sink space



Product code: 527458.
RRP: £118 inc. VAT.

BLANCO Storage Caddy

NEW



Storage Caddy 20.
Product code: 527667.
RRP: £178 inc. VAT.

Key Features

- Offers storage for bottles or other utensils
- The portable caddy is easy to remove and place back on the movable base tray
- Easy access thanks to the handle and the full extension sliding function

Available as a portable single or double caddy



Storage Caddy 40.
Product code: 527668.
RRP: £238 inc. VAT.

Inspiration#1&2.

Sink Options

BLANCO ETAGON 500-U

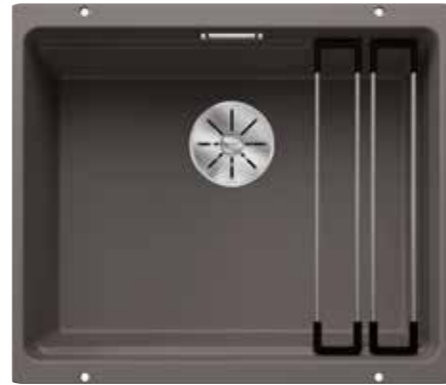
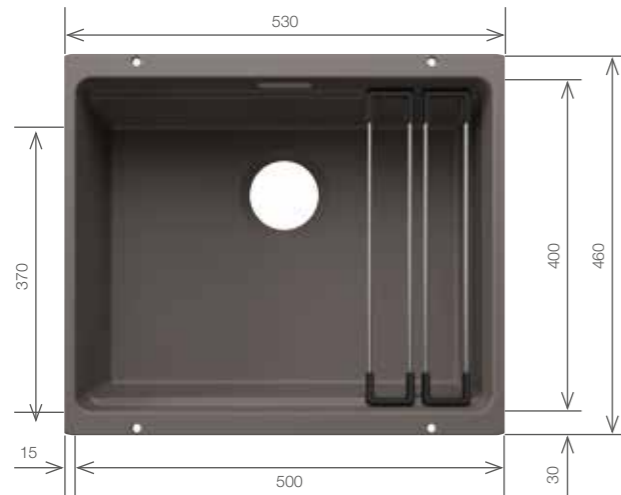

Using the Coloured Components system as shown in Inspiration 1 — select your InFino® set from the opposite page to perfectly match your style. Colour shown is volcano grey. Product code: 527755. RRP: £684 inc. VAT.

As shown in Inspiration 2: sink with stainless steel InFino® and overflow set and waste kit included, to match the CHOICE Icona tap in brushed stainless steel. Colour shown is volcano grey. Product code: 527258. RRP: £802 inc. VAT.



Key Features

- Stylish Silgranit® undermount sink designed for 600mm cabinets
- Integrated step creates an additional functional level within the sink area
- Supplied with a set of ETAGON rails
- Bowl depth: 200mm

Specification

Cabinet Size Minimum Requirement mm	600
Undermount Installation type	

COLOUR OPTION PRODUCT CODES

	anthracite	rock grey	white	tartufo	coffee	black	volcano grey	soft white
 <p>NEW As shown in Inspiration 1 ETAGON 500-U using the Coloured Components system RRP: £684 inc. VAT each</p>	527757	527758	527759	527761	527760	527754	527755	527756
 <p>As shown in Inspiration 2 ETAGON 500-U with a stainless steel InFino® and overflow set included RRP: £802 inc. VAT each</p>	522227	522228	522231	522234	522236	525887	527258	527075

SILGRANIT® COLOURS

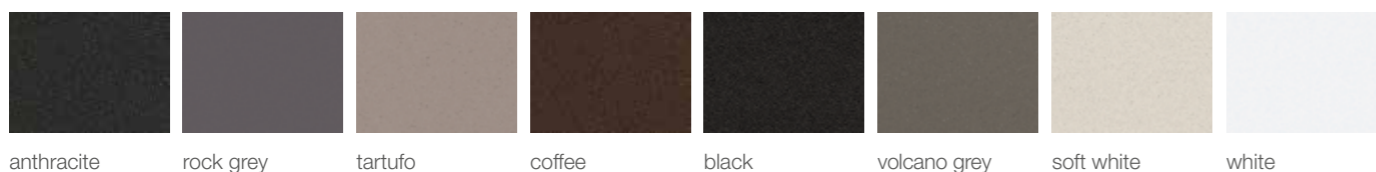

Scan the QR code for the full ETAGON range:



Use the coloured component system to customise your kitchen water place.

Tap: CHOICE Icona in matt black. Product code: 527657.
Sink: ETAGON 500-U in volcano grey with Coloured Components, product code: 527755. Colour Component set in black. Product code: 207422.
In cabinet: SELECT II 40/2 combi. Product code: 527854. CHOICE.All water conditioning unit. Product code: 527661 Water Carafe. Product code: 527671.

An InFino® Coloured Component set needs be purchased additionally to perfectly match your style **NEW**

 <p>Black matt Product code: 207422 RRP: £178 inc. VAT each</p>	 <p>Satin gold Product code: 207423 RRP: £178 inc. VAT each</p>	 <p>Satin dark steel Product code: 207424 RRP: £202 inc. VAT each</p>	 <p>Satin platinum Product code: 207425 RRP: £202 inc. VAT each</p>
--	--	--	--

Inspiration#3. Tap Options

BLANCO CULINA-S II and BLANCO CULINA-S II Mini

NEW



BLANCO CULINA-S II
Colour shown is satin dark steel.
Product code: 527465.
RRP: £658 inc. VAT.



BLANCO CULINA-S II Mini
Colour shown is satin dark steel.
Product code: 527469.
RRP: £598 inc. VAT.

Key Features

- Iconic tap with an exquisite design and semi-professional functionality
- Flexible metal hose offers optimal freedom of movement
- Two jets and integrated flow stop: easy to switch between ventilated, soft jet and powerful, high spray function
- BLANCO CULINA-S II Mini version: ideal in combination with wall cupboards

Specification

High Pressure	
Extendable spray	
Pull-out dual spray	

Other colour and finish options



BLANCO CULINA-S II
PVD steel
Product code: 527463.
RRP: £598 inc. VAT.



BLANCO CULINA-S II
Satin platinum
Product code: 527702.
RRP: £658 inc. VAT.



BLANCO CULINA-S II
Black matt
Product code: 527464.
RRP: £598 inc. VAT.



BLANCO CULINA-S II Mini
PVD steel
Product code: 527467.
RRP: £538 inc. VAT.



BLANCO CULINA-S II Mini
Satin platinum
Product code: 527703.
RRP: £598 inc. VAT.



BLANCO CULINA-S II Mini
Black matt
Product code: 527468.
RRP: £538 inc. VAT.



Shown in Inspiration#3:

Tap: BLANCO CULINA-S II in satin dark steel. Product code: 527465.
Sink: CLARON 700-U Satin Dark Steel Edition. Product code: 527835.

BLANCO CULINA-S II Sensor and BLANCO CULINA-S II Mini Sensor

NEW



BLANCO CULINA-S II Sensor
Colour shown is PVD steel.
Product code: 527462.
RRP: £1,198 inc. VAT.



BLANCO CULINA-S II Mini Sensor
Colour shown is PVD steel.
Product code: 527466.
RRP: £1,138 inc. VAT.



Wave sensor on tap body



Pot-filler sensor starts automatically for quick filling with cold water

Key Features

- Manual or hands-free operation with ingenious dual sensor technology
- Wave sensor on the tap body to activate hands free operation
- Wave sensor on spray arm to activate quick filling of pots and pans

Specification

High Pressure	
Extendable spray	
Pull-out dual spray	
Senso	

Inspiration#3.

BLANCO CLARON DARK STEEL EDITION 700-U

NEW

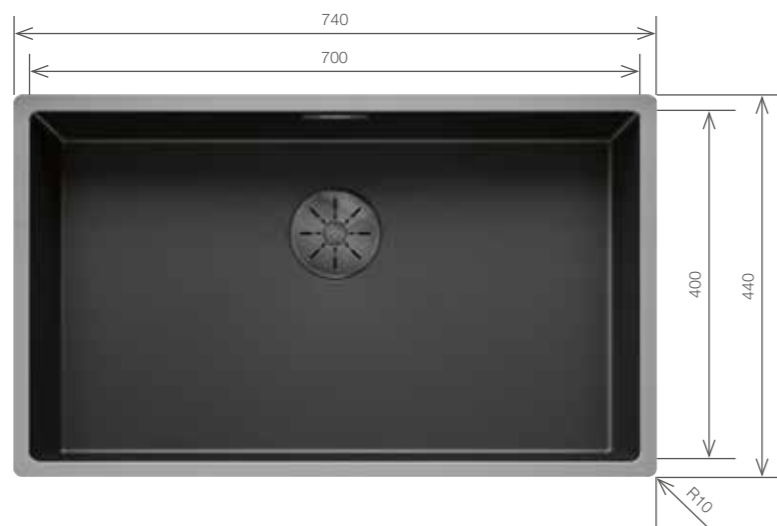

Colour shown is dark steel.
Product code: 527835.
RRP: £1,558 inc. VAT.

Key Features

- Striking dark grey surface due to being high quality, pure, non-coated stainless steel
- Dark steel is not a coating, it's part of the steel itself
- Extra deep bowl and smallest possible radii makes for optimal bowl utilisation
- In this edition, seamlessly co-ordinated look with InFino® set in elegant satin dark steel
- Bowl depth: 190mm

Specification

Cabinet Size Minimum Requirement mm	800
Undermount Installation type	

OTHER CLARON DARK STEEL EDITION SINK SIZE OPTIONS

NEW

CLARON 500-U (for 600mm cabinets)

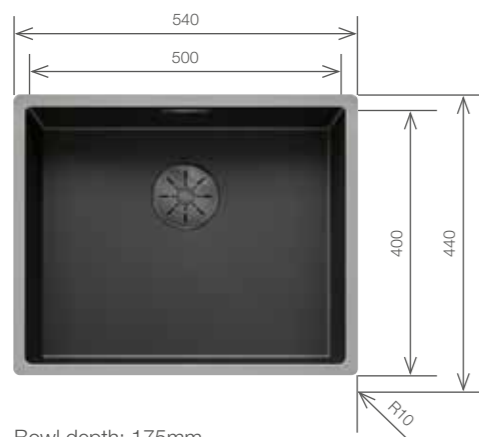

Bowl depth: 175mm
Colour shown is dark steel.
Product code: 527834.
RRP: £1,198 inc. VAT.



BLANCO FWD MAX



Key Features

- Safe, hygienic, clean and convenient way to dispose of leftover foods
- Grinds down food waste (without the need of knives or blades) and deposits it into the drain
- Reduces the amount of food waste sent to landfill sites
- Ultra quiet operation with powerful AC induction motor

Product code: 456440.
RRP: £682 inc. VAT.

BLANCO BOTTON II 30/2



Key Features

- Functionally designed waste system with integrated handles for easy emptying
- Can be used in any base cabinet 300mm or greater
- Total capacity = 30 litres (2 x 15 litre bins)
- Can be flexibly positioned
- Suitable for a hinged cabinet door

Product code: 526376.
RRP: £154 inc. VAT.



In-cabinet waste system: 2 x BOTTON II 30/2. Product code: 526376.
Food Waste Dispenser: FWD MAX. Product code: 456440.

Inspiration#4.

BLANCO SONEA-S Flexo



Key Features

- Classic semi-professional tap design with accents in black for the modern kitchen
- High quality design in solid brushed stainless steel
- Flexible black hose provides optimal range of motion
- Dual spray with easy switch from standard stream to powerful rinse spray
- Precise magnetic holder ensures convenient hose docking

Specification

High Pressure



Extendable spray



Pull-out dual spray



Colour shown is solid brushed stainless steel.
Product code: 526616.
RRP: £538 inc. VAT.



Shown in Inspiration#4:

Tap: SONES-S Flexo in solid brushed stainless steel. Product code: 526616.

Sink: ADIRA 6 S in volcano grey. Product code: 527604.

In-cabinet waste system: SELECT II 60/2. Product code: 526203. (ADIRA colander is placed within the larger waste compartment for demonstration purposes, to add additional functionality. Additional colander is not included with this waste system).



BLANCO SELECT II 60/2



Key Features

- Functionally designed waste system with integrated handles for easy emptying
- Total capacity 49 litres (1 x 30 litre and 1 x 19 litre bins)
- Can be used in any base cabinet 600mm
- Quick and easy to install
- Suitable for a pull out cabinet door

Product code: 526203.
RRP: £370 inc. VAT.

Inspiration#4.

BLANCO ADIRA 6 S

NEW



Colour shown is volcano grey.
Product code: 527604.
RRP: £718 inc. VAT.



Shown in Inspiration#4:
Sink: ADIRA 6 S in volcano grey. Product code: 527604.

Key Features

- Stylish Silgranit® inset sink
- Hardworking sink thanks to the large main bowl, additional small bowl and flat draining zone
- The multifunctional ADIRA folding grid is included and can be used as an additional work station
- A multifunctional colander also included which sits neatly in the second bowl
- Bowl depth: 200mm / 135mm

Specification

Cabinet Size Minimum Requirement mm	600
Universal Fitment	
Inset Installation	

OTHER ADIRA SINK SIZE OPTIONS

ADIRA XL 6S (for 600mm cabinets)

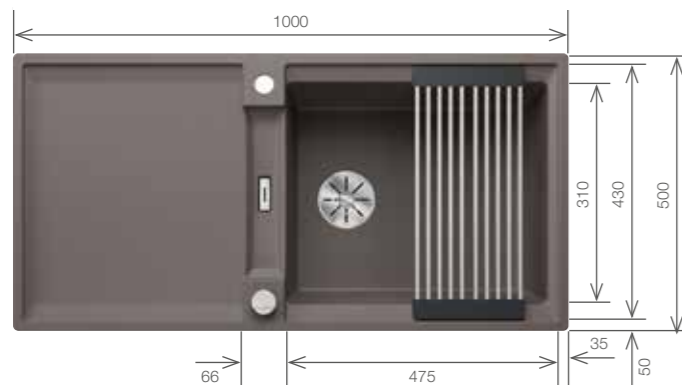

Bowl depth: 200mm
Colour shown is volcano grey.
Product code: 527620.
RRP: £658 inc. VAT.

ADIRA 45 S (for 450mm cabinets)

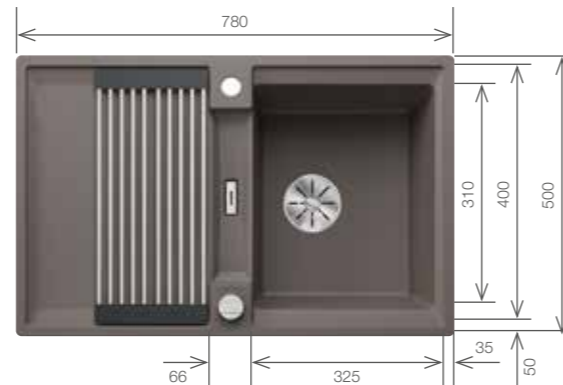

Bowl depth: 200mm
Colour shown is volcano grey.
Product code: 527588.
RRP: £574 inc. VAT.

COLOUR OPTION PRODUCT CODES

		anthracite	rock grey	white	tartufo	coffee	black	volcano grey	soft white
	ADIRA 6 S RRP: £718 inc. VAT each	527602	527603	527605	527607	527608	527601	527604	527606
	ADIRA XL 6S RRP: £658 inc. VAT each	527618	527619	527621	527623	527624	527617	527620	527622
	ADIRA 45 S RRP: £574 inc. VAT each	527586	527587	527589	527591	527592	527585	527588	527590

SILGRANIT® COLOURS

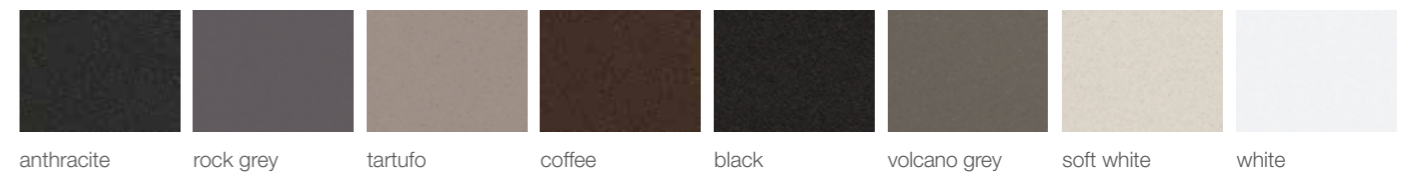

Inspiration#5.

BLANCO drink.hot EVOL-S PRO



Key Features

- 4-in-1 semi-professional tap with 100°C filtered boiling, filtered cold, hot and cold water
- Intuitive measuring function delivers an exact volume of filtered boiling or filtered cold water
- Five stage filter reduces limescale and improves water taste
- Separate insulated spout for filtered drinking and boiling water, which can be used simultaneously with the flexible spout which delivers warm and cold mains water

Colour shown is PVD steel.
Product code: 526313.
RRP: £2,398 inc.VAT.

Specification

Hot	
Volume	
Filter System	
High Pressure	
Extendable spray	



Other colour and finish options



Satin gold
Product code: 527429.



Black matt
Product code: 526635.

RRP: £2,398 inc. VAT each



Shown in Inspiration#5:

Tap: drink.hot EVOL-S Pro in black matt. Product code: 526635.
Sink: ETAGON 500-U (using Coloured Components system) in black. Product code 527754.
InFino® overflow set in black matt purchased separately. Product code 207422.

BLANCO SELECT II COMPACT 60/2



Key Features

- Functionally designed waste system with integrated handles for easy emptying
- Ideal in combination with BLANCO drink.hot system because it can fit in front of the hot water tank
- Total capacity = 34 litres (2 x 17 litre bins)
- Can be used in any base cabinet 600mm
- Suitable for a pull out cabinet door

Product code: 526207.
RRP: £286 inc. VAT.

BLANCO ETAGON 500-U



Scan the QR code for the full ETAGON range:



ETAGON 500-U (without drainage components)
Colour shown is black.
Product code: 527754.
RRP: £684 inc. VAT.

Key Features

- Stylish Silgranit® undermount sink designed for 600mm cabinets
- Integrated step creates an additional functional level within the sink area
- Supplied with a set of ETAGON rails
- Bowl depth: 200mm

Specification

Cabinet Size Minimum Requirement mm	600
Undermount Installation type	

OTHER ETAGON SINK SIZE OPTIONS CODES – SUPPLIED WITHOUT DRAINAGE COMPONENTS

ETAGON 700-U

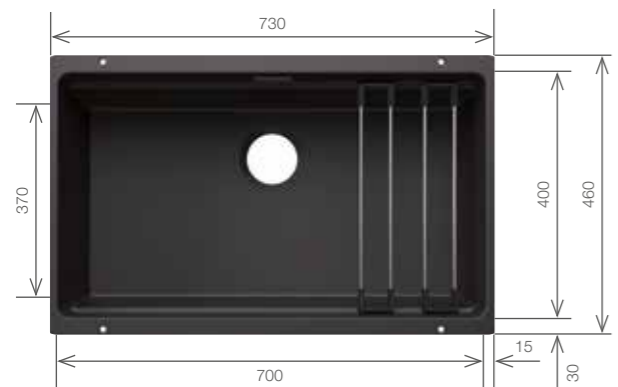



ETAGON 700-U (without drainage components)
Bowl depth: 200mm
Colour shown is black.
Product code: 527762.
RRP: £780 inc. VAT.



ETAGON 700-U in black with a black matt Coloured Components set

COLOUR OPTION CODES WITHOUT DRAINAGE COMPONENTS

	anthracite	rock grey	white	tartufo	coffee	black	volcano grey	soft white
 ETAGON 500-U RRP: £684 inc. VAT each	527757	527758	527759	527761	527760	527754	527755	527756
 ETAGON 700-U RRP: £780 inc. VAT each	527765	527766	527767	527769	527768	527762	527763	527764

For more ETAGON size options available with Coloured Component sets see page 46-47

An InFino® Coloured Component set needs be purchased additionally to perfectly match your style NEW



Black matt
Product code: 207422
RRP: £178 inc. VAT each



Satin gold
Product code: 207423
RRP: £178 inc. VAT each

SILGRANIT® COLOURS

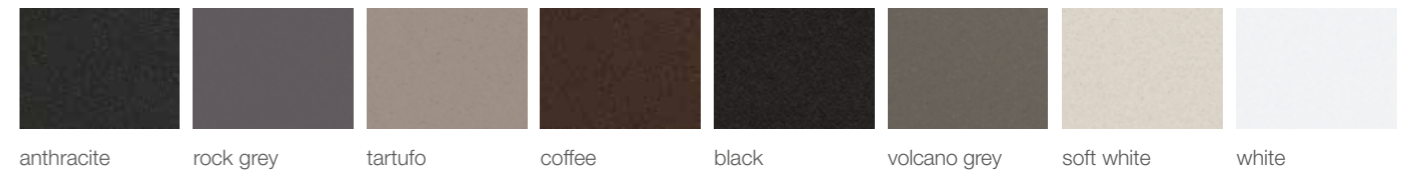

BLANCO Water carafes – Hold up to one litre of freshly poured water straight from your filter tap

OPTIONAL ACCESSORIES



Product code:
Clear glass 527671.
RRP: £58 inc. VAT each



Product code:
Frosted glass 527672.
RRP: £58 inc. VAT each

Inspiration#6.

BLANCO LINUS-S



Key Features

- Minimalist design
- Stylish L shaped spout with extendable spray head
- High spout for easy filling

Specification

High Pressure



Extendable spray



Colour shown is satin gold.
Product code: 526684.
RRP: £574 inc. VAT.



Shown in Inspiration #6:

Tap: LINUS-S in satin gold. Product code: 526684.
Sink: SUBLINE 800-U in soft white. Product code: 527174. InFino® overflow set in satin gold purchased separately.
Product code: 203476.

Scan the QR code
for the full
LINUS-S range:

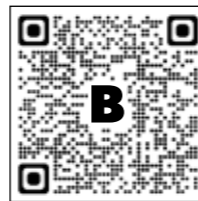

BLANCO BOTTON II 30/2



Key Features

- Functionally designed waste system with integrated handles for easy emptying
- Can be used in any base cabinet 300mm or greater
- Total capacity = 30 litres (2 x 15 litre bins)
- Suitable for a hinged cabinet door

Product code: 526376.
RRP: £154 inc. VAT.



In-cabinet waste system: 2 x BOTTON II 30/2. Product code: 526376.

Inspiration#6.

BLANCO SUBLINE 800-U



Scan the QR code for the full SUBLINE range:



This sink comes with stainless steel InFino® drainage and overflow components as standard but you can upgrade these with different Coloured Components. Satin gold InFino® set as shown in the lifestyle imagery on page 18 – product code: 203476. RRP: £118 inc. VAT. This version of the satin gold InFino® set comes without the waste kit as it comes supplied already with the SUBLINE 800-U. Colour shown is soft white. Product code: 527174. RRP: £886 inc. VAT.

Key Features

- Stylish Silgranit® undermount sink designed for 900mm cabinets
- Elegantly integrated InFino® basket strainer, making it easier to dispose of sink waste
- Bowl depth: 220mm

Specification

Cabinet Size Minimum Requirement mm	900
Undermount Installation type	

SILGRANIT® COLOURS

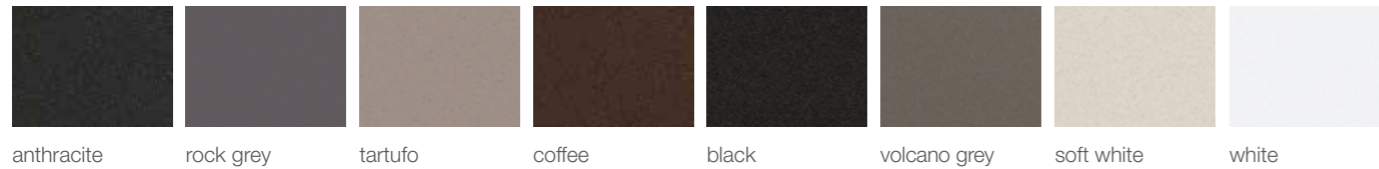

OTHER SUBLINE SINK SIZE OPTIONS WITHOUT DRAINAGE COMPONENTS

These options come without drainage components allowing you to choose your preferred complementing Coloured Components including InFino® drain system and overflow plus waste kit. These sinks below do not come with these as standard, they need to be ordered separately.

SUBLINE 500-U

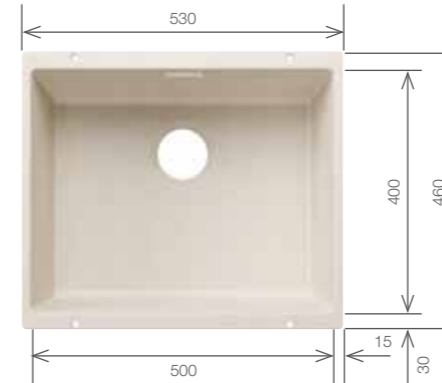

Bowl depth: 190mm
Colour shown is soft white.
Product code: 527796.
RRP: £660 inc. VAT.

SUBLINE 340/160-U

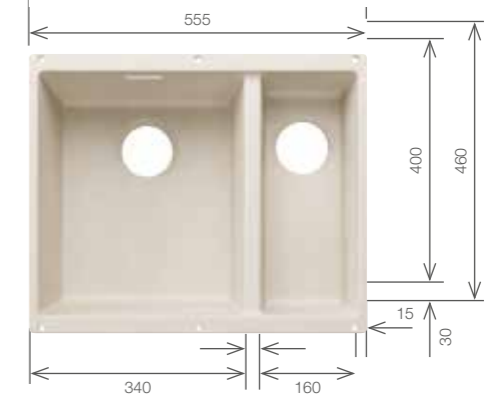

Bowl depth: 190mm / 130mm
Colour shown is soft white.
Main bowl left product code: 527820.
Main bowl right product code: 527812.
RRP: £720 inc. VAT.

SUBLINE 350/350-U

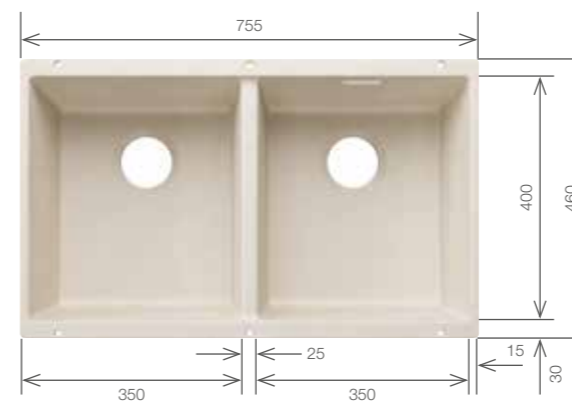

Bowl depth: 200mm / 200mm
Colour shown is soft white.
Product code: 527828.
RRP: £780 inc. VAT.

An InFino® Coloured Component set which includes a waste kit needs to be purchased additionally to perfectly match your style



NEW

Satin gold
Product code: 207423.
RRP: £178 inc. VAT.

Satin gold double set
Product code: 207439.
RRP: £274 inc. VAT.

Inspiration#7.

The new BLANCO Coloured Components system offers maximum flexibility to customise your own kitchen water place. With this system, you can combine the individual components for the tap, sink and InFino® drainage and overflow set, coordinate them with each other and create your own individual look.



Shown in Inspiration#7:

Tap: LINUS-S in satin platinum. Product code: 527699.
Sink: SUBLINE 500-U in tartufo (without drainage components). Product code 527801. Satin platinum Coloured Components set. Product code 207425.

1. CHOOSE YOUR SINK MODEL AND COLOUR.

Other size options are available, full selection on blanco.co.uk

SINK COLOUR OPTIONS WITHOUT THE DRAINAGE COMPONENTS

NEW

		anthracite	rock grey	white	tartufo	coffee	black	volcano grey	soft white
	ETAGON 700-U RRP: £780 inc. VAT each	527765	527766	527767	527769	527768	527762	527763	527764
	ETAGON 500-U RRP: £684 inc. VAT each	527757	527758	527759	527761	527760	527754	527755	527756
	ETAGON 6 RRP: £672 inc. VAT each	527749	527750	527751	527753	527752	527746	527747	527748
	SUBLINE 700-U RRP: £744 inc. VAT each	527805	527806	527807	527809	527808	527802	527803	527804
	SUBLINE 500-U RRP: £660 inc. VAT each	527797	527798	527799	527801	527800	527794	527795	527796
	SUBLINE 340/160 Left hand bowl RRP: £720 inc. VAT each	527821	527822	527823	527825	527824	527818	527819	527820
	SUBLINE 340/160 Right hand bowl RRP: £720 inc. VAT each	527813	527814	527815	527817	527816	527810	527811	527812

2. CHOOSE YOUR INFINO® DRAINAGE AND OVERFLOW SET.

Use the product code below to add your matching InFino® set to match the tap material of your choice:

InFino® Coloured Component sets

NEW

Black matt Single set product code: 207422. RRP: £178 inc. VAT. Double set product code: 207438. RRP: £274 inc. VAT.	Satin gold Single set product code: 207423. RRP: £178 inc. VAT. Double set product code: 207439. RRP: £274 inc. VAT.	Satin dark steel Single set product code: 207424. RRP: £202 inc. VAT. Double set product code: 207440. RRP: £298 inc. VAT.	Satin platinum Single set product code: 207425. RRP: £202 inc. VAT. Double set product code: 207441. RRP: £298 inc. VAT.

3. CHOOSE YOUR TAP.

Use the product code below to match your LINUS-S tap finish and material with your InFino® set:

Colour and finish options to match your Coloured Components

Black matt Product code: 525807. RRP: £574 inc. VAT.	Satin gold Product code: 526684. RRP: £574 inc. VAT.	Satin dark steel Product code: 527733. RRP: £658 inc. VAT.	Satin platinum Product code: 527699. RRP: £658 inc. VAT.

See age 42 for LINUS-S product specification.

Inspiration#8.

BLANCO CATRIS-S



Key Features

- Semi-professional mixer tap
- Flexible spout with a stainless steel spring on a movable spray
- Variable jet options; change from aerated stream to powerful rinse spray

Specification

High Pressure	
Extendable spray	
Pull-out dual spray	

Colour shown is chrome.
Product code: 521476.
RRP: £406 inc. VAT.



Scan the QR code for the full CATRIS range:



Shown in Inspiration #8:

Tap: CATRIS-S in chrome. Product code: 521476.
Sink: SUBLINE 700-U in white. Product code 523446.

BLANCO SUBLINE 700-U

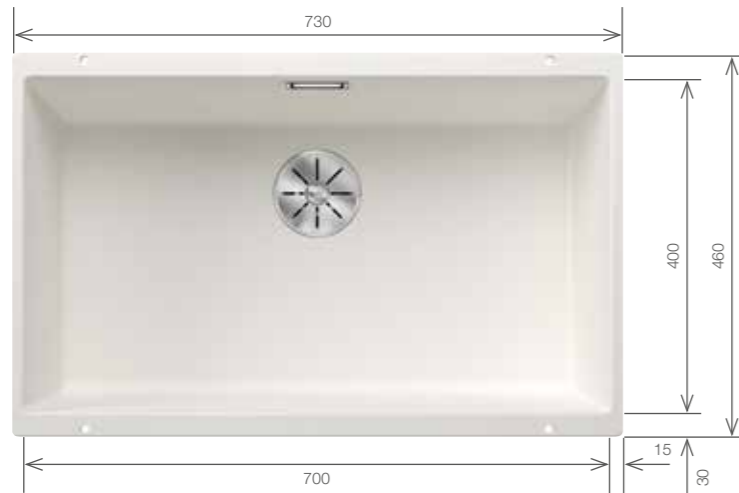

Scan the QR code for the full SUBLINE range:



Colour shown is white.
Product code: 523446.
RRP: £862 inc. VAT.

OTHER SUBLINE SINK SIZE OPTIONS

SUBLINE 500-U

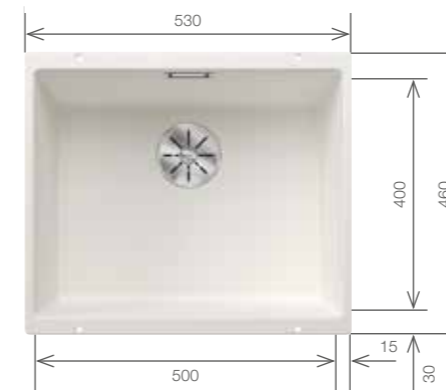

Colour shown is white.
Product code: 523436.
RRP: £778 inc. VAT.



Key Features

- Stylish and classic undermount Silgranit® sink
- Elegantly integrated InFino® basket strainer, making it easier to dispose of sink waste
- Bowl depth: 190mm

Specification

Cabinet Size Minimum Requirement mm	800
Undermount Installation type	

SILGRANIT® COLOURS

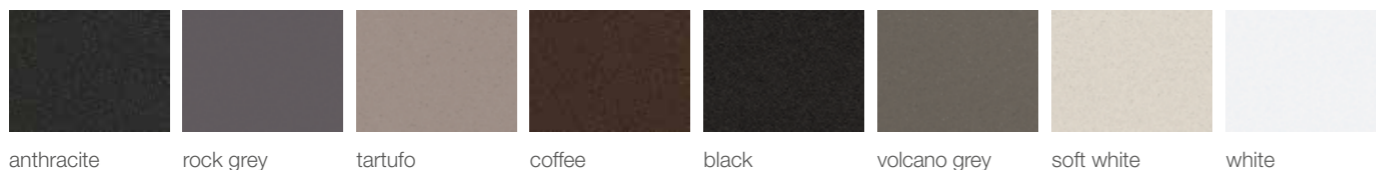

BLANCO FWD MEDIUM



Key Features

- Safe, hygienic, clean and convenient way to dispose of leftover foods
- Grinds down food waste (without the need of knives or blades) and deposits it into the drain
- Reduces the amount of food waste sent to landfill sites
- Quiet operation with powerful AC induction motor

Product code: 456439.
RRP: £610 inc. VAT.

Inspiration#9.

BLANCO SONEA-S Flexo



Key Features

- Classic semi-professional tap design with accents in black for the modern kitchen
- Flexible black hose provides optimal range of motion
- Dual spray with easy switch from standard stream to powerful rinse spray

Specification

High Pressure	
Extendable spray	
Pull-out dual spray	

Colour shown is brushed stainless steel.
Product code: 526616.
RRP: £538 inc. VAT.

BLANCO METRA XL 6 S



Scan the QR code for the full METRA range:



Colour shown is white.
Product code: 515280.
RRP: £634 inc. VAT.

Key Features

- Stylish Silgranit® inset sink
- The large capacity of the bowl provides generous room to do the washing up coupled with a spacious draining area
- 3½" basket strainer plus remote control pop-up waste
- Can be installed reversibly
- Bowl depth: 190mm

Specification

Cabinet Size Minimum Requirement mm	600
Inset Installation	



BLANCO FWD MEDIUM



Key Features

- Safe, hygienic, clean and convenient way to dispose of leftover foods
- Grinds down food waste (without the need of knives or blades) and deposits it into the drain
- Reduces the amount of food waste sent to landfill sites
- Quiet operation with powerful AC induction motor

Product code: 456439.
RRP: £610 inc. VAT.

OTHER METRA SINK SIZE OPTIONS

METRA 6 S



Bowl depth: 190mm / 145mm
Colour shown is white.
Product code: 513046.
RRP: £646 inc. VAT.

METRA 5 S



Bowl depth: 190mm
Colour shown is white.
Product code: 513037.
RRP: £622 inc. VAT.

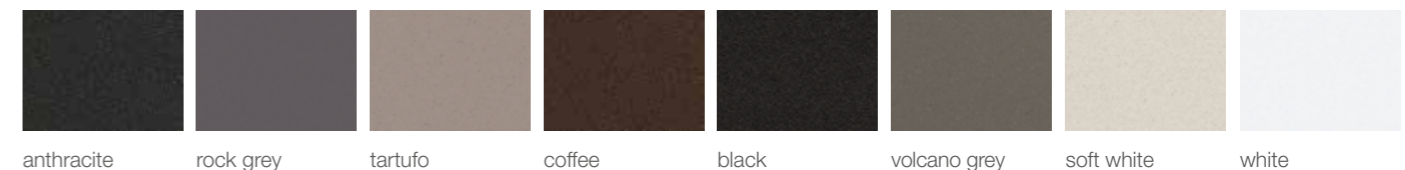

SILGRANIT® COLOURS



Inspiration#10.

BLANCO CANDOR Twin





Key Features	Specification
<ul style="list-style-type: none"> • High quality solid brushed stainless steel • Ideal mixer tap design for modern kitchens • High arched outlet 	Low Pressure 
	Solid Spout 

Colour shown is solid brushed stainless steel.
Product code: 526703.
RRP: £406 inc.VAT.

OTHER CANDOR TAP OPTIONS

BLANCO CANDOR-S





Key Features	Specification
<ul style="list-style-type: none"> • Single lever and pull-out spray • Pull-out metal tap head on a flexi-hose 	High Pressure 
	Pull-out spray 

Colour shown is solid brushed stainless steel.
Product code: 523121.
RRP: £418 inc. VAT.

BLANCO CANDOR



Key Features	Specification
<ul style="list-style-type: none"> • High quality solid brushed stainless steel • Ideal mixer tap design for modern kitchens 	High Pressure 
	Solid Spout 

Colour shown is solid brushed stainless steel.
Product code: 523120.
RRP: £346 inc. VAT.

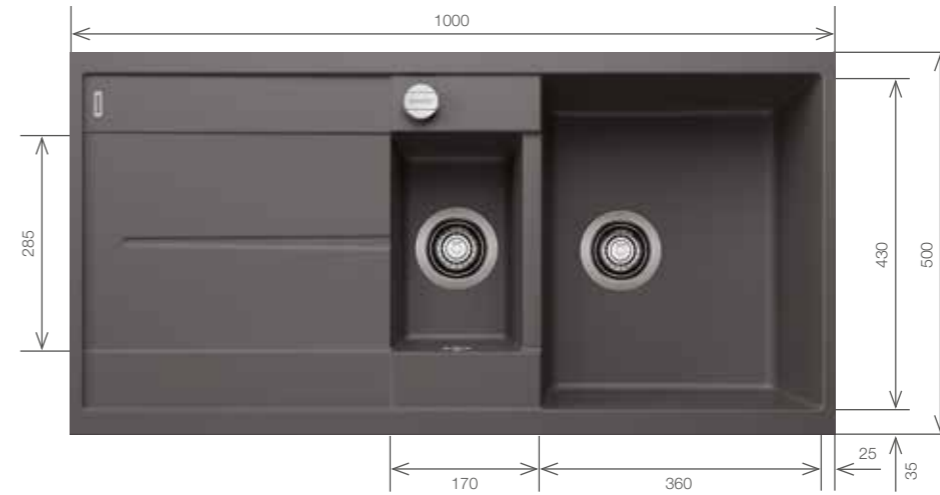

BLANCO METRA 6 S

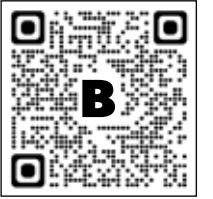

Scan the QR code for the full METRA range:



Colour shown is rock grey.
Product code: 518877.
RRP: £646 inc. VAT.

Key Features	Specification
<ul style="list-style-type: none"> • Stylish Silgranit® inset sink • The additional bowl and the spacious draining area provides added functionality • Remote control pop-up waste for main bowl • Supplied with a stainless steel colander • Bowl depth: 190mm / 145mm 	Cabinet Size Minimum Requirement mm 600
	Universal Fitment 
	Inset Installation 

For other METRA size options see page 51

SILGRANIT® COLOURS

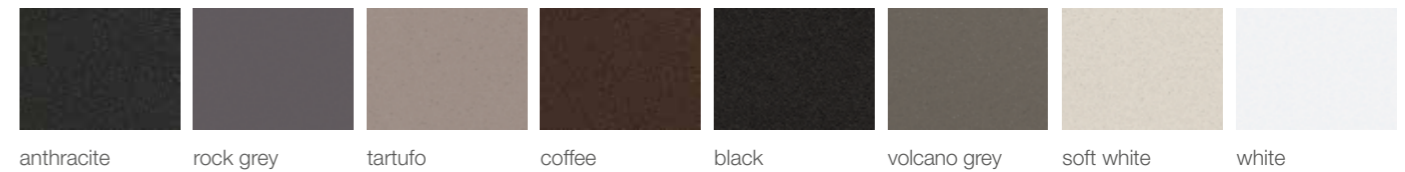

BLANCO FWD MEDIUM



Key Features
<ul style="list-style-type: none"> • Safe, hygienic, clean and convenient way to dispose of leftover foods • Reduces the amount of food waste sent to landfill sites • Quiet operation with powerful AC induction motor

BLANCO BOTTON PRO 60/3 MANUAL



Key Features
<ul style="list-style-type: none"> • Functionally designed bins with integrated handles for easy emptying • Easy-glide ball guidance for full extension • Total capacity = 39 litres (3 x 13 litre bins) • Best space utilisation for 450mm and 600mm base cabinets

FWD product code: 456439. RRP: £610 inc. VAT.
Waste organiser: 517469 RRP: £178 inc VAT.





Inspiration#11.

BLANCO CATRIS-S Flexo Filter



Colour shown is PVD steel.
Product code: 526706.
RRP: £646 inc.VAT.
Filter set: Product code: 527453.
RRP: £418 inc. VAT.

Colour shown is black matt.
Product code: 526707.
RRP: £646 inc.VAT.
Filter set: Product code: 527453.
RRP: £418 inc.VAT.

Key Features	Specification
<ul style="list-style-type: none"> • 3-in-1 mixer tap in semi-professional design for cold, warm and filtered water • Dual spray with integrated flow stop: easy switch from standard stream to powerful rinse spray • Filtered water dispensed from separate spout • Multi-stage filter reduces limescale and improves taste • Needs to be installed with a BLANCO water filter system (to be purchased separately) 	Filter System 
	High Pressure 
	Extendable spray 
	Pull-out dual spray 

Non filter version is available. See website for details.



Scan the QR code for the full CATRIS range:



Shown in Inspiration #11:
Tap: CATRIS-S Flexo Filter in PVD steel. Product code: 526706. RRP: £646 inc. VAT.
Filter set: Product code: 527453. £418 inc. VAT.
Sink: ANDANO 500-U in stainless steel. Product code: 522967. RRP: £550 inc. VAT.
LATO soap dispenser in PVD steel. Product code: 525809. RRP: £166 inc. VAT.

BLANCO ANDANO 500-U

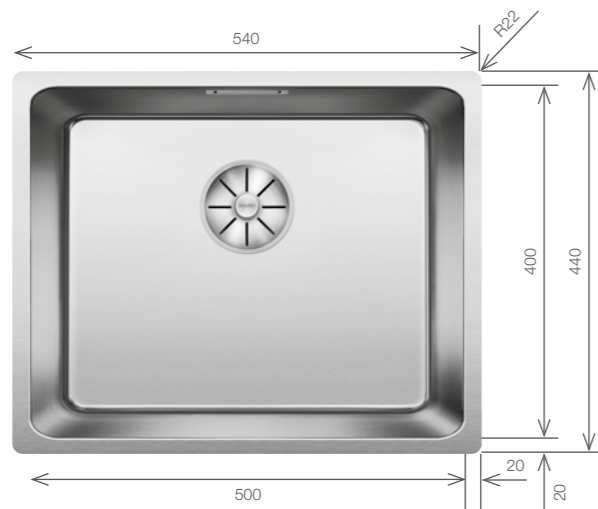

Colour shown is stainless steel, satin polish.
Product code: 522967.
RRP: £550 inc. VAT.



Key Features	Specification
<ul style="list-style-type: none"> • Classic, timeless finish in stainless steel • Elegantly integrated InFino® basket strainer, making it easier to dispose of sink waste • Bowl depth 190mm 	Cabinet Size Minimum Requirement mm 600
	Undermount Installation type 

OTHER ANDANO SINK SIZE OPTIONS

ANDANO 700-U

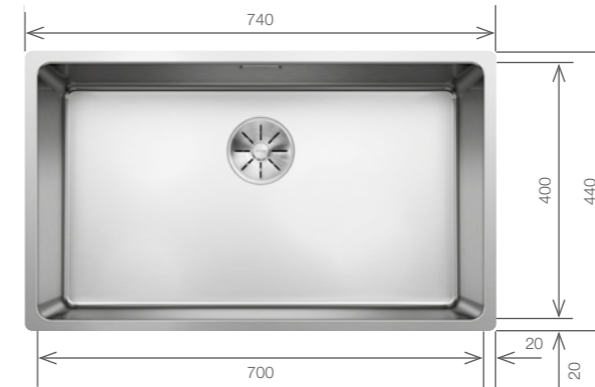

Bowl depth: 190mm
Colour shown is stainless steel, satin polish.
Product code: 522971.
RRP: £658 inc. VAT.

ANDANO 340/180-U

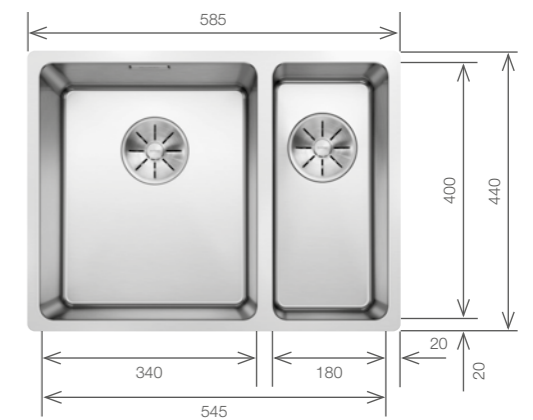

Bowl depth: 190mm / 130mm
Colour shown is stainless steel, satin polish.
Main bowl left (shown) product code: 522979.
Main bowl right product code: 522977.
RRP: £718 inc. VAT.

Inspiration#11.



Shown in Inspiration #11:

Tap: CATRIS-S Flexo Filter in PVD steel. Product code: 526706. RRP: £646 inc. VAT.
 Filter set: Product code: 527453. RRP: £418 inc. VAT.
 Sink: ANDANO 500-U in stainless steel. Product code 522967. RRP: £550 inc. VAT.
 LATO soap dispenser in PVD steel. Product code: 525809. RRP: £166 inc. VAT.
 Top rails (shown on image left). Product code: 235906. RRP: £94. inc. VAT.
 Multifunctional colander in stainless steel. Product code: 227689. RRP: £70. inc. VAT.
 In-cabinet waste system: BOTTON II 30/2. Product code 526376. RRP: £154 inc. VAT.

Scan the QR code
for the full
ANDANO range:



BLANCO BOTTON II 30/2



Key Features

- Functionally designed waste system with integrated handles for easy emptying
- Can be used in any base cabinet 300mm or greater
- Total capacity = 30 litres (2 x 15 litre bins)
- Suitable for a hinged cabinet door

Product code: 526376.
RRP: £154 inc. VAT.

Inspiration#12.

BLANCO MAX II



Key Features

- Twin lever mixer tap
- High arch long reach spout
- Modern timeless design

Specification

Low Pressure



Solid Spout



Colour shown is black matt.
Product code: 527525.
RRP: £298 inc. VAT.

BLANCO SONA 6 S

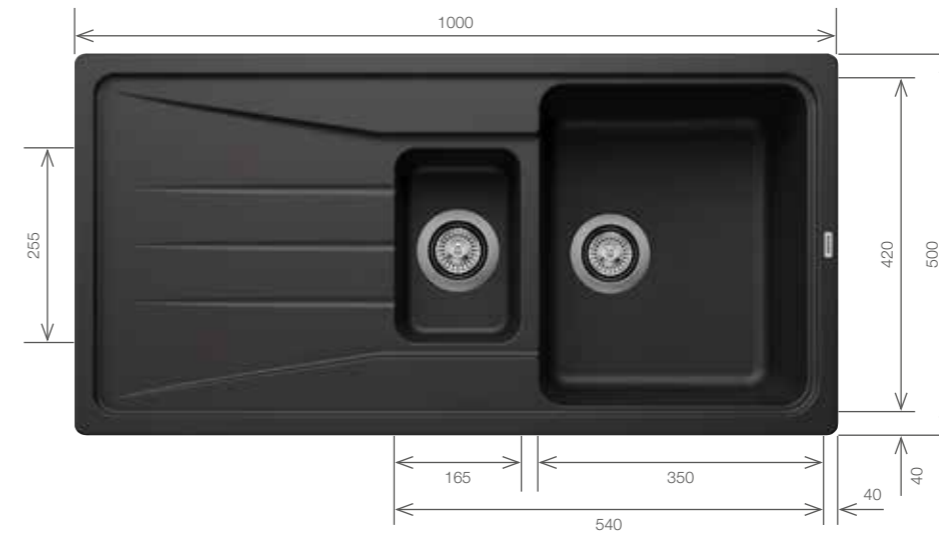

Scan the QR code
for the full
SONA range:

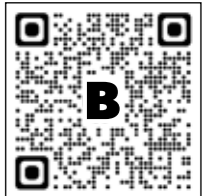

Colour shown is black.
Product code: 525975.
RRP: £526 inc. VAT.

Key Features

- Stylish Silgranit® inset sink designed for 600mm cabinets
- Kitchen tasks are made much easier by the roomy main bowl and practical additional bowl
- Bowl depth: 190mm / 120mm

Specification

Cabinet Size Minimum Requirement mm

600

Universal Fitment



Inset Installation



Inspiration#12.

Other colour and finish options



Shown in Inspiration #12:
Tap: MAX II in black matt. Product code: 527525.
Sink: SONA 6 S in black matt. Product code: 525975.

BLANCO FWD MEDIUM



Key Features

- Safe, hygienic, clean and convenient way to dispose of leftover foods
- Grinds down food waste (without the need of knives or blades) and deposits it into the drain
- Reduces the amount of food waste sent to landfill sites
- Quiet operation with powerful AC induction motor

Product code: 456439.
RRP: £610 inc. VAT.

BLANCO BOTTON II 30/2



Key Features

- Functionally designed bins with integrated handles for easy emptying
- Can be used in any base cabinet 300mm or greater
- Total capacity = 30 litres (2 x 15 litre bins)
- Suitable for a hinged cabinet door

Product code: 526376.
RRP: £154 inc. VAT.

OTHER SONA SINK SIZE OPTIONS

SONA 5 S

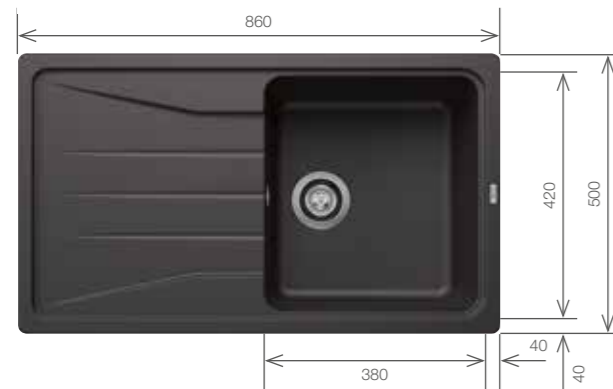

Bowl depth: 190mm
Colour shown is black.
Product code: 525972.
RRP: £478 inc. VAT.

SONA XL 6 S

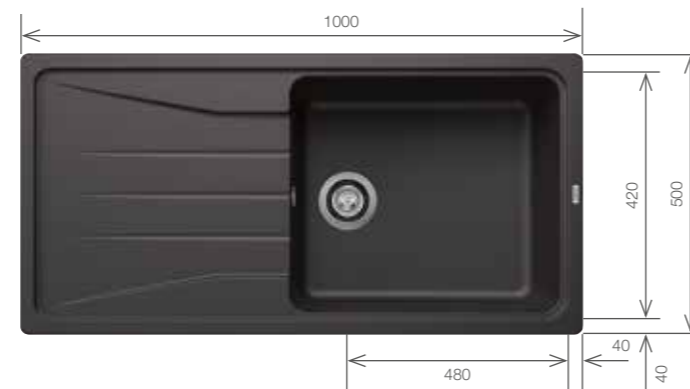

Bowl depth: 190mm
Colour shown is black.
Product code: 525977.
RRP: £490 inc. VAT.

SILGRANIT® COLOURS

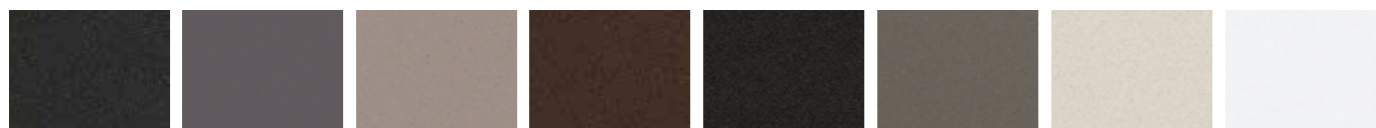

anthracite rock grey tartufo coffee black volcano grey soft white white



In-cabinet waste system: BLANCO BOTTON II 30/2. Product code: 526376. RRP: £154 inc. VAT.
Food Waste Dispenser: FWD Medium. Product code: 456439. RRP: £610 inc. VAT.

ACCESSORIES TO MAKE KITCHEN TASKS EASIER.

Choose from the BLANCO range of ingenious accessories to transform your sink into a multi-functional workplace in just a few simple steps. In order to make best use of the space over the sink, you can often use other sink accessories such as multi-functional colanders or a foldable grid. Even in small kitchens, these can provide additional working surfaces to carry out many tasks.



CHOPPING BOARDS.

A wide variety of quality chopping boards are available – in a variety of woods, glass or high-quality plastic. These are specially made to be used over the sink or by the side, to allow for a flexible chopping space.



WORKTOP ORGANISATION.

To help keep it tidy on the worktop, these organisation aids can be flexibly placed on the worktop or straddled across the sides of BLANCO bowls. They provide easy access to key items around the sink, like soap dispensers or cleaning products and reduce clutter on your work top.



COLANDERS.

A variety of stainless steel colanders allow for rinsing and draining pasta or vegetables right in the sink, making this kitchen task so much simpler.



FOLDABLE GRID.

Transform your sink into a modern kitchen workspace with our foldable grids. These can be placed on the drainer, over the bowl or on the worktop, to use for draining washed items or filling up pots. It's easy to stow away and vary the positioning on the drainer, thanks to the practical folding function.

BLANCO FOOD WASTE DISPOSERS.

A smart addition to your BLANCO UNIT. The most environmentally-friendly, time efficient and hygienic way to grind down and flush away food waste.

BETTER KITCHEN HYGIENE.

Avoids the mess of traditional bins that often create unpleasant odours and bacteria growth.

SMARTER USE OF TIME.

A quick and easy way to dispose of food during meal preparation, food waste just goes straight down the sink. Meaning less time is spent cleaning out your food waste bins.

SAFE AND SIMPLE TO USE.

No knives or blades are used. All moving parts are blunt. Controlled by the touch of a button, with only cold running water needed to assist. Because the device is rinsed during the grinding process, it requires little additional care.



LIMIT YOUR LANDFILL.

Ground-up food is flushed away into your regular system and treated at the water plant, usually by converting it into soil conditioner that can be turned into clean energy. The FWD is installed directly beneath the sink and grinds food waste so finely it flows through your sewage pipe easily.

HOW YOUR FWD GENERATES GREEN POWER.*

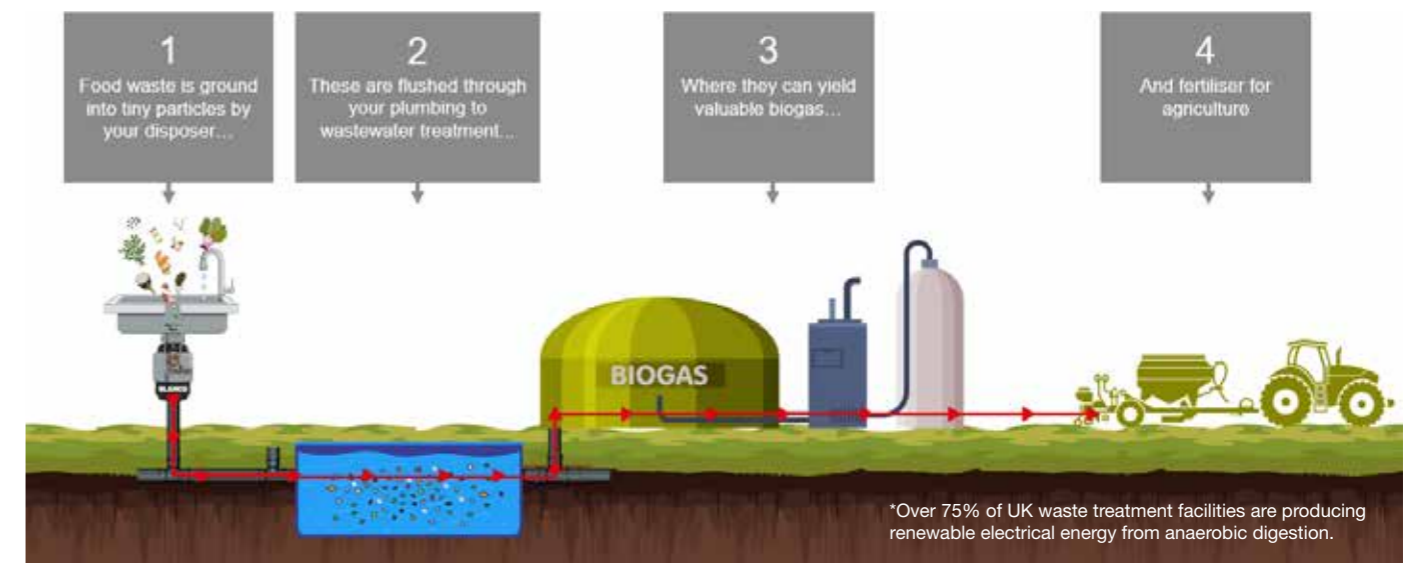

THE BLANCO FWD RANGE IN MAX, MEDIUM AND LITE FITS MOST BLANCO SINKS AND BOWLS.

SILGRANIT® COLOUR OPTIONS.

Silgranit's beautiful, smooth and tactile surface is available in a range of design-oriented colours. Colour is such an important part of our lives, especially in our homes. It's a fundamental aspect of interior design and we use it as an expression of our own style. The palette of Silgranit sink colours runs from monochrome black and white, through to on-trend greyscale shades, into warm earth tones.

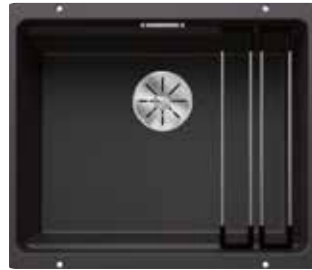

black



anthracite



rock grey



volcano grey

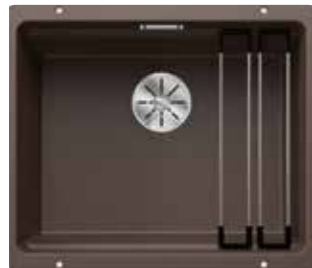

coffee



tartufo



soft white



white

TAP COLOUR AND FINISH RANGE.

Metallics and special colours



chrome black matt PVD steel



satin gold brushed stainless steel



satin dark steel satin platinum

Silgranit-Look colour range



black anthracite rock grey volcano grey



coffee tartufo soft white white

TAPS AND SINKS EXPLAINED.

A key to important features and considerations.

We have highlighted on page 6 the importance of knowing your sink cabinet size and what type of sink installation format you are looking for, whether it is inset, undermount or Belfast (apron front bowl). Here is some additional information you'll need to think about when choosing your sink and tap.

TAPS.

Water pressure

BLANCO has a range of taps suitable for low and high pressure systems. BLANCO considers taps 0.3 bar and below as low pressure.

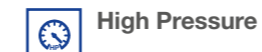

Features

- Pull-Out Spray:** Features a pull-out spray, useful for directional rinsing.
- Extendable Spray:** Features a pull-out spray hose for extended work area.
- Solid Spout:** Tap spout does not extend.
- Senso Version:** Includes hands-free Start-Stop mode with sensor technology.

SINK PROFILES.

BLANCO sinks come with a range of different profiles.

Inset installation / installation from above: The frame of an inset sink sits on top of the work surface and is installed from above. These sinks are compatible with any work surface, including laminate worktops.

IF and IF/A: Unique 1mm flat edge profile for inset flush installation.

Undermount: Installed underneath the work surface.

BOWL CONFIGURATION.

Select the correct sink configuration for your kitchen.

UNI (Universal) indicates an inset sink suitable for both left and right configurations.

TAP FLOW RATES EXPLAINED.

Before choosing your BLANCO tap it is essential to check whether you have a high or low pressure water system.

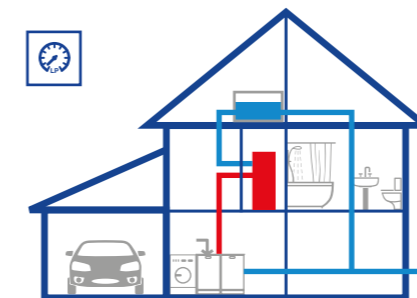

Low pressure (Gravity-fed system)

You have a cold water tank in your attic and a hot water tank in your airing cupboard. You should choose taps which state they are suitable for a low pressure system.

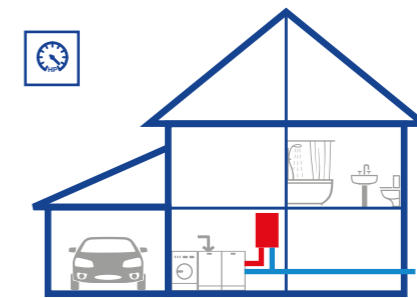

High pressure (Combi-boiler system)

You have a boiler unit but no hot water cylinder, the boiler unit is usually found in the kitchen and delivers hot water on demand. You should be able to choose from most of our taps.

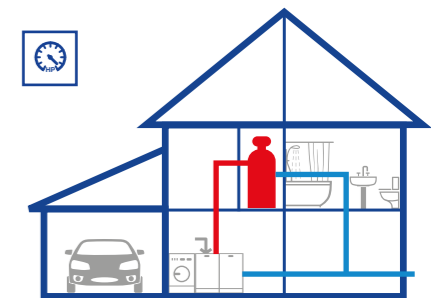

High pressure (Pumped system)

You have a hot water cylinder with an expansion vessel on top (often called Megaflo), usually found in the airing cupboard, but you do not have a cold water tank. You should be able to choose any of our taps.

BLANCO UK Limited: The Inspirations Collection only represents a small selection from our UK range. If you require details about our complete range of sinks, taps, waste organisers, waste disposal units and accessories, please contact your local BLANCO dealer, or visit www.blanco.co.uk

To view this brochure online scan the QR code below:



We work directly with our BLANCO partners to bring you the most competitive prices available for our products. Please find your nearest BLANCO partner using the Dealer Locator on our website, or scan the QR code below:



Please note that colour references are only as accurate as the printing process will allow. E & OE. Due to a policy of continual product improvement, BLANCO UK Limited reserves the right to alter specifications and prices without prior notice. All dimensions quoted in this publication including cut out details are to be used as a sales guide only. Always refer to the fitting instructions and cut out details supplied with the actual sink when installing. Cut out sizes are also available on our website.

©BLANCO UK Limited (within the UK and Republic of Ireland on behalf of BLANCO GmbH & Co KG) 2024. All rights reserved. Without limiting the rights reserved under copyright above, no part of this publication may be reproduced, stored in or introduced into a retrieval system, or transmitted, in any form or by any means (electronic, mechanical, photocopying, cording or otherwise), without the prior written express permission of the copyright owner.

BLANCO UK Limited
Tel: 01923 635 200

Customer Services
Tel: 01923 635 201
Email: info@blanco.co.uk

Sales Orders
Tel: 01923 635 202
Email: orders@blanco.co.uk
www.blanco.co.uk

Dealer



This brochure is printed on FSC certified paper using vegetable based inks and we offset the carbon footprint of our printing by partnering with the World Land Trust.